

**QUAD BIPOLAR OPERATIONAL AMPLIFIERS**

- LOW DISTORTION RATIO
- LOW NOISE
- VERY LOW SUPPLY CURRENT
- LOW INPUT OFFSET CURRENT
- VERY LOW INPUT OFFSET VOLTAGE
- LARGE COMMON-MODE RANGE
- HIGH GAIN
- HIGH OUTPUT CURRENT
- GAIN-BANDWIDTH PRODUCT : 2.5MHz
- TEMPERATURE DRIFT :  $2\mu\text{V}/^\circ\text{C}$
- LONG TERM STABILITY :  $8\mu\text{V}/\text{YEAR}$   
(for  $T_{\text{amb}} \leq 50^\circ\text{C}$ )
- THE TEB4033 AND TEF4033 ARE PIN TO PIN REPLACEMENT OF THE LS204C AND LS204I RESPECTIVELY

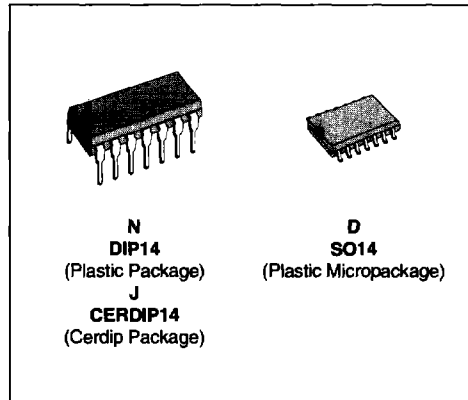

**DESCRIPTION**

The TEB4033, TEF4033 and TEC4033 are high performance quad-operational amplifiers intended for active filter applications. The internal phase compensation allows stable operation as voltage follower in spite of their high gain-bandwidth products. The circuits present very stable electrical characteristics over the entire supply voltage range.

**ORDER CODES**

Part Number	Temperature Range	Package		
		N	J	D
TEB4033	0°C, +70°C	•	•	•
TEF4033	-40°C, +105°C	•	•	•
TEC4033	-55°C, +125°C	•	•	•

**Example : TEB4033N**

4033-01.TBL

**PIN CONNECTIONS (top view)**

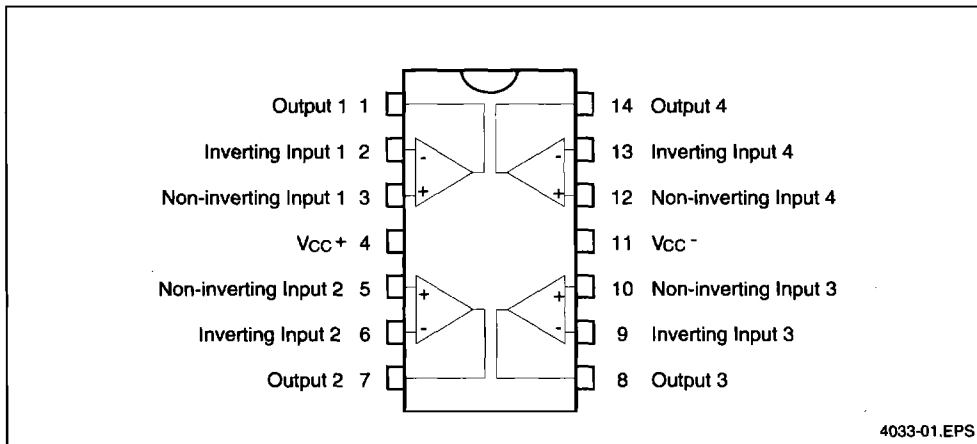

## BLOCK DIAGRAM (1/4 TEB4033)

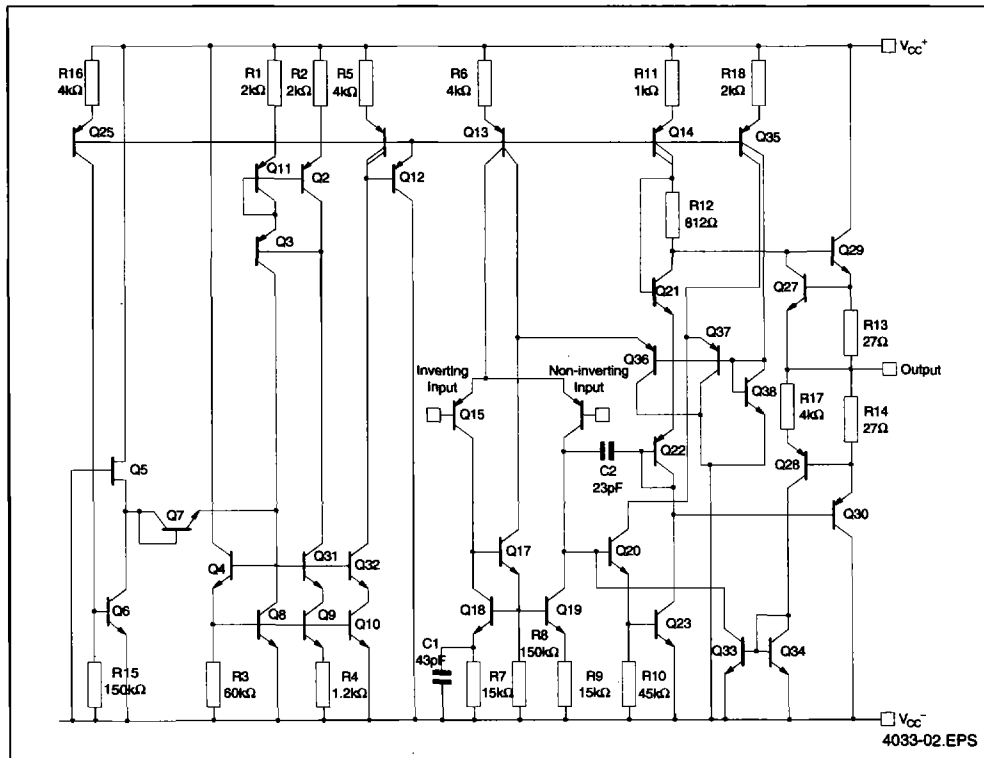

## ABSOLUTE MAXIMUM RATINGS

Symbol	Parameter		Value	Unit
$V_{cc}$	Supply Voltage		$\pm 18$	V
$V_i$	Input Voltage		$\pm V_{cc}$	V
$V_{id}$	Differential Input Voltage		$\pm (V_{cc} - 1)$	V
$P_{tot}$	Power Dissipation	D suffix N suffix	400 665	mW
$T_{oper}$	Operating Free-air Temperature Range		0 to +70 -40 to +105 -55 to +125	$^{\circ}\text{C}$
$T_{stg}$	Storage Temperature Range		-65 to +150	$^{\circ}\text{C}$

**ELECTRICAL CHARACTERISTICS** $V_{CC} = \pm 15V$ ,  $T_{amb} = +25^{\circ}C$  (unless otherwise specified)

Symbol	Parameter	TEB 1033 TEF 1033 TEC 1033			Unit
		Min.	Typ.	Max.	
$V_{io}$	Input Offset Voltage ( $R_S \leq 10k\Omega$ ) $T_{amb} = 25^{\circ}C$ $T_{min.} \leq T_{amb} \leq T_{max.}$		0.3	1 3	mV
$DV_{io}$	Input Offset Voltage Drift		2		$\mu V/^{\circ}C$
$I_{io}$	Input Offset Current $T_{amb} = 25^{\circ}C$ $T_{min.} \leq T_{amb} \leq T_{max.}$		5	20 40	nA
$I_{ib}$	Input Bias Current $T_{amb} = 25^{\circ}C$ $T_{min.} \leq T_{amb} \leq T_{max.}$		50	100 200	nA
$A_{vd}$	Large Signal Voltage Gain ( $R_L = 2k\Omega$ , $V_O = \pm 10V$ ) $T_{amb} = 25^{\circ}C$ $T_{min.} \leq T_{amb} \leq T_{max.}$	80 40	120		V/mV
SVR	Supply Voltage Rejection Ratio ( $DV_{CC}$ from $\pm 15V$ to $\pm 4V$ ) $T_{amb} = 25^{\circ}C$ $T_{min.} \leq T_{amb} \leq T_{max.}$	80 70	100		dB
$I_{CC}$	Supply Current, all Amp, no Load $T_{amb} = 25^{\circ}C$ $T_{min.} \leq T_{amb} \leq T_{max.}$		2	3 4	mA
$V_{icm}$	Input Common Mode Voltage Range $T_{amb} = 25^{\circ}C$	$\pm 12$			V
CMR	Common Mode Rejection Ratio ( $R_S \leq 10k\Omega$ , $V_I = \pm 10V$ ) $T_{amb} = 25^{\circ}C$ $T_{min.} \leq T_{amb} \leq T_{max.}$	80 70	100		dB
$I_{os}$	Output Short-circuit Current $T_{amb} = 25^{\circ}C$ $T_{min.} \leq T_{amb} \leq T_{max.}$	10 10	23	40 40	mA
$\pm V_{opp}$	Output Voltage Swing $T_{amb} = 25^{\circ}C$ $T_{min.} \leq T_{amb} \leq T_{max.}$ $V_{CC} = \pm 4V$ , $R_L = 2k\Omega$ , $T_{amb} = 25^{\circ}C$ $V_{CC} = \pm 6V$ , $R_L = 600\Omega$ , $T_{amb} = 25^{\circ}C$		$R_L = 2k\Omega$ 13 12 3 $R_L = 2k\Omega$		V
SR	Slew-rate ( $V_I = \pm 10V$ , $R_L = 2k\Omega$ , $C_L = 100pF$ , $T_{amb} = 25^{\circ}C$ , unity gain)	0.6	1		V/ $\mu s$
GBP	Gain Bandwidth Product ( $f = 100kHz$ , $T_{amb} = 25^{\circ}C$ , $V_{in} = 10mV$ , $R_L = 2k\Omega$ , $C_L = 100pF$ )	1.5	2		MHz
$R_i$	Input Resistance		1		M $\Omega$
THD	Total Harmonic Distortion ( $f = 1kHz$ , $A_v = 20dB$ , $R_L = 2k\Omega$ , $C_L = 100pF$ , $T_{amb} = 25^{\circ}C$ , $V_o = 2V_{pp}$ )		0.008	0.05	%
$e_n$	Equivalent Input Noise Voltage ( $f = 1kHz$ ) $R_S = 50\Omega$ $R_S = 1k\Omega$ $R_S = 10k\Omega$		8 10 18	15	$\frac{nV}{\sqrt{Hz}}$
$V_{OPP}$	Large Signal Voltage Swing $R_L = 10k\Omega$ , $f = 10kHz$	26	28		V
$\phi_m$	Phase Margin		45		Degrees
$V_{O1}/V_{O2}$	Channel Separation	100	120		dB

4033-03.TBL

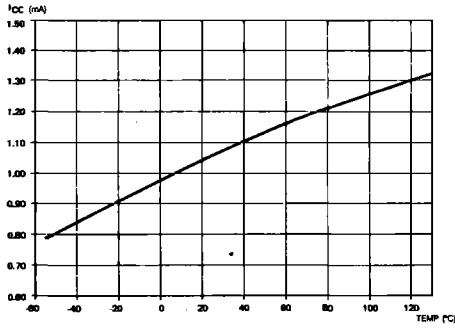

SUPPLY CURRENT VS. AMBIENT TEMPERATURE

4033-03.EPS

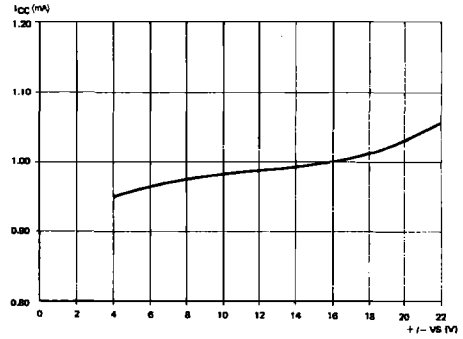

SUPPLY CURRENT VS. SUPPLY VOLTAGE

4033-04.EPS

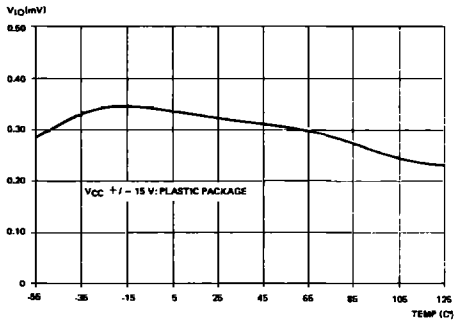

OFFSET VOLTAGE VS. AMBIENT TEMPERATURE

4033-05.EPS

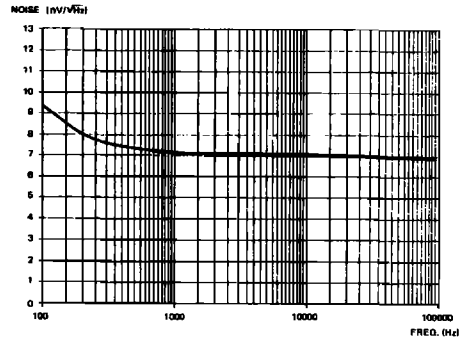

TOTAL INPUT NOISE VS. FREQUENCY

4033-06.EPS

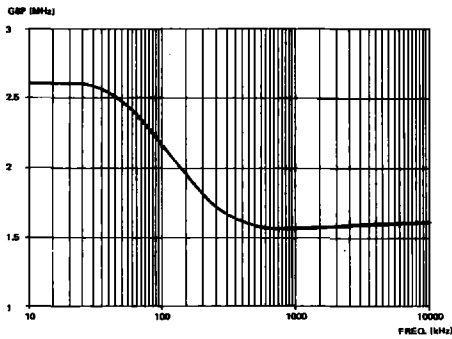

GAIN BANDWIDTH PRODUCT VS. FREQUENCY

4033-07.EPS

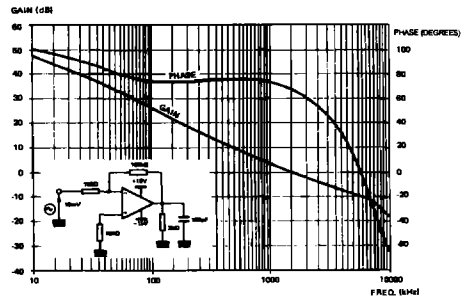

BODE PLOT

4033-08.EPS

## TYPICAL APPLICATION

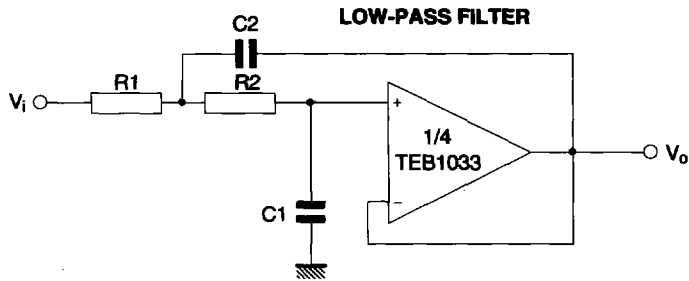

$$\frac{V_o}{V_i} = \frac{1}{1 + 2\xi \frac{S}{\omega_c} + \frac{S^2}{\omega_c^2}}$$

$\omega_c = 2\pi f_c$ , with  $f_c$  = cut-off frequency  
 $\xi$  = damping factor

4033-09.EPS